



Welcome to the World of
E-Collar Technologies Incorporated

FOB Educator

FE-560B

(FE-560B TX, RX-050, FT-030 TX)

FE-562B

(FE-560B TX, RX-050, RX-050, FT-030 TX)

Owner's Manual

**“Happiness is a Well
Behaved Dog”**



FE-560B Series E-Collar

Remote Education Collar

Dear valued customer,

Congratulations on the recent purchase of your E-Collar training system. We are confident that you will be pleased with the results achieved through the use of our e-collar training system. We have taken great care to incorporate numerous safety features to ensure a positive experience for both you and your dog.

To maximize your success, it is crucial to employ the lowest level of stimulation and approach the training process with patience and understanding. By applying gentle leash pressure and using a low level of stimulation, you will achieve the best outcomes. It is important for your dog to recognize the sensation from the stimulation as a means of communication, rather than something to be feared.

It is recommended that the use of our training system be incorporated into a comprehensive training program. We suggest taking the time to familiarize yourself with the features and functions of your E-Collar before placing the collar on your dog. Additionally, please consider subscribing to our YouTube and Facebook pages for educational resources on the proper use of e-collars.

We wish you the best of luck with your training endeavors and encourage you to reach out to us at any time for assistance.

This guide is designed to provide you with assistance on the fundamental functions, programming features, and contents of your E-Collar training system. For further information and support, please visit www.ecollar.com or reach out to us at customer-service@ecollar.com.

We encourage you to contact our esteemed customer service department for any inquiries you may have at (260) 357-0051.

TABLE OF CONTENTS

- Important Notice	03
- Characteristics	04
- Package Contents	05
- Device Operation	06
- Charging the Batteries	08
- Turning Your E-collar ON/OFF	10
- Correctly Fitting Collar	12
- LCD Display Description	13
- Function Description	14
- Button Operation	15
- Programming Mode	19
- How to Find the Proper Stimulation Level	22
- Stimulation Level Button Lock/Unlock	23
- Rising Stimulation	24
- Replace/Add Collar	25
 Two Dog FE-562B Specifics	
- 562B LCD Display Description	26
- 562B Function Description	27
- 562B Button Operation	28
- 562B Programming Mode	33
- 562B Stimulation Level Button Lock/Unlock	38
- 562B Rising Stimulation	40
- Finger Trainer	42
- Pairing Finger Trainer With Transmitter	43
- Changing The Button The Finger Trainer Controls On The Transmitter	44
- Turn on/off Finger Trainer detection function for power save	45
- Operating Distance And Battery Of Finger Trainer	46
- Testing Your E-collar	47
- Replacing the Contact Points	48
- Training Tips	49
- Troubleshooting	50
- Two Year Warranty	51
- Accessories	52
- Safety and General Information	53
- Technical Specifications	56

IMPORTANT NOTICE

This product is specifically designed for canine use only.

E-Collar Technologies, Inc. assumes no responsibility for any misuse of this product, including damages caused by dog bites and lost items. Before using this product on aggressive dogs, it is advised to seek an evaluation by a professional trainer. It is not uncommon for aggressive dogs to associate the stimulation with the handler and potentially act against them. In some cases, dogs that are subjected to e-collar pressure during a fight may display redirected aggression and become even more aggressive.

The use of high levels of stimulation should only be considered as a last resort and in life-threatening situations. To avoid unintentionally stimulating your dog, it is recommended to keep the stimulation level below 5 when the product is not in use.

The effective range of your E-Collar training device may be influenced by various factors such as terrain, weather conditions, presence of trees or power lines, and potential interference from other wireless devices. Positioning the transmitter for maximum range.

For optimal range, grasp the transmitter in a manner similar to holding a torch, such as the one held by the Statue of Liberty. Ensure that the antenna remains separate from your body and fingers at all times, as touching the antenna can significantly diminish the range.



[Long Range]



[Medium Range]



[Short Range]

04

CHARACTERISTICS

- Range : 300 Yards
- Two Stimulation Modes (Continuous/Rising Stimulation)
- 3 Functions Settable Front Button (Tone/Vibrations/Stimulation)
- Tapping Sensation or Tone Stimulation (Pavlovian Conditioning)

Tapping Sensation: Alternative to Stimulation

(vibration similar to a Cell Phone)

Tone Stimulation: After 1.2 seconds of tone, the collar will send continuous stimulation at the conditioning level as long as button is pressed (up to 10 seconds), leads to "Pavlovian Conditioning" whereby the dog responds to the tone.

- Quick Charge Li-polymer Batteries
- User Settable Max. Limit Level (5 to 100)
- User Settable Ramping up Speed to Max.
- Limit Level (0 sec./1sec./ 2sec./5sec.)
Stimulation Levels Adjustable from 1 to 100
- Collar Receiver Light for locating your dog at night
- Lock and Set Stimulation Safety Feature
- Stimulation Boosting Mode provides instant control when normal stimulation is ignored - great for emergency situations.
- Completely Waterproof and Shock Resistant
- Convertible from 1-Dog model (FE-560B) to 2-Dog model (FE-562B)
- Remote Finger Button (FT-030) supported

PACKAGE CONTENTS

- Transmitter

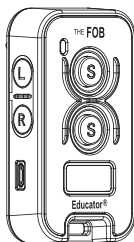

- Collar Receiver with Strap
(FE-562B Package includes
2 Receivers and straps)

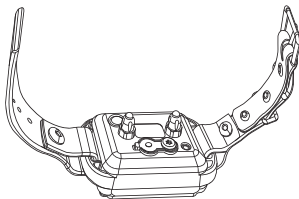

- Finger Trainer



- Battery Charger
(FE-562B package contains
splitter cable)

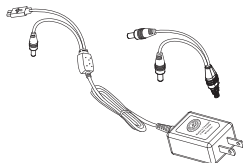

- Owner's Manual



- Extra Contact Points 3/4"



- Test Light

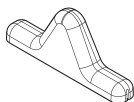

- Contact Point Tool



- Lanyard



DEVICE OPERATION

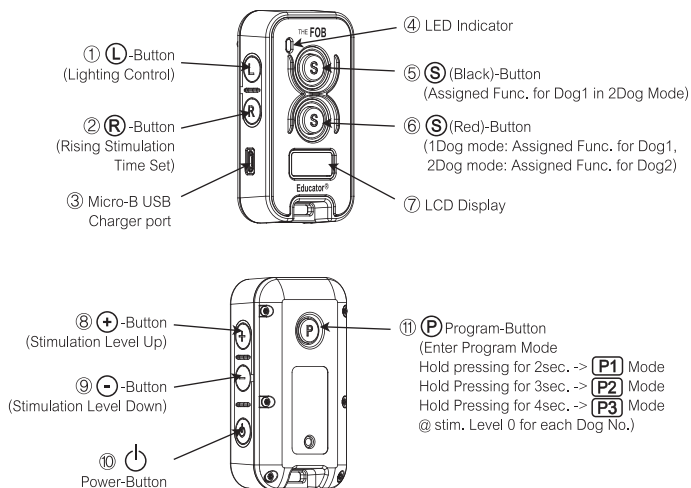

- ① **L**-Button : Selecting Lighting mode operation
- ② **R**-Button : Selecting the operation time of Rising Stimulation Mode
- ③ Micro-B USB Charger port : Transmitter Charging Port (Micro-B type USB)
- ④ LED Indicator : Indicate signal transmission status and Battery status.
- ⑤ **S** (Black)-Button : Stimulation operation with set stimulation level
- ⑥ **S** (Red)-Button : Operation with preset mode among
Stimulation / Tone / Vibration / Rising Stimulation mode
- ⑦ LCD Display : Indicates Transmitter transmission level, operation status, and Dog1/Dog2 status
- ⑧ **+**-Button : Stimulation Level Up
- ⑨ **-**-Button : Stimulation Level Down
- ⑩ Power-Button : Transmitter Power ON/OFF
- ⑪ **P** Program-Button : Enter programming mode & Dog select in 2Dog mode

DEVICE OPERATION

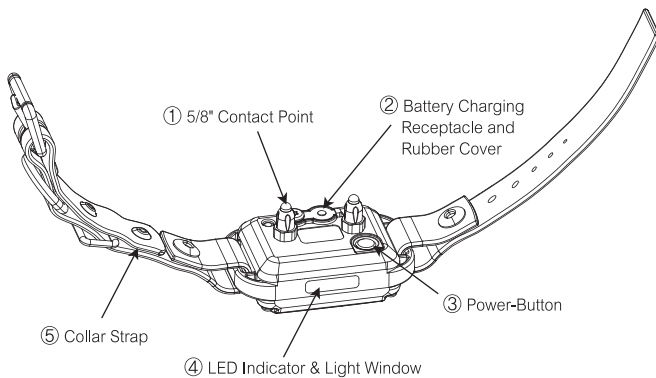

- ① 5/8" Contact Point
- ② Battery Charging Receptacle and Rubber Cover
- ③ Power-Button : Receiver Power ON/OFF
- ④ LED Indicator & Light Window : Battery indicator & Light
- ⑤ Collar Strap

CHARGING THE BATTERIES

Indicator Light is blinking “Green” under normal operation.
solid “Red” when stimulation is applied.
blinking “Red” when recharging is required.

Do not allow the batteries to get hot or be fully discharged, store at room temperature and 50% capacity charge.

Transmitter Battery Charging

The Micro-B USB charging cable can be used to charge the product.

Micro-B USB Charger port

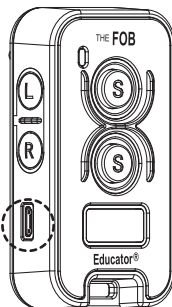

The indicator light will turn solid red during charge cycles and turn green when it is fully charged. (approximately 2 hours)

Your e-collar is equipped with Li-Polymer batteries that need specific attention to ensure their longevity. It is advisable to avoid fully discharging the battery. In the event of complete discharge, please recharge it promptly to prevent irreversible damage. Additionally, please keep the units away from excessive heat and cold temperatures.

CHARGING THE BATTERIES

Collar Receiver Battery Charging Receptacle and Rubber Cover.

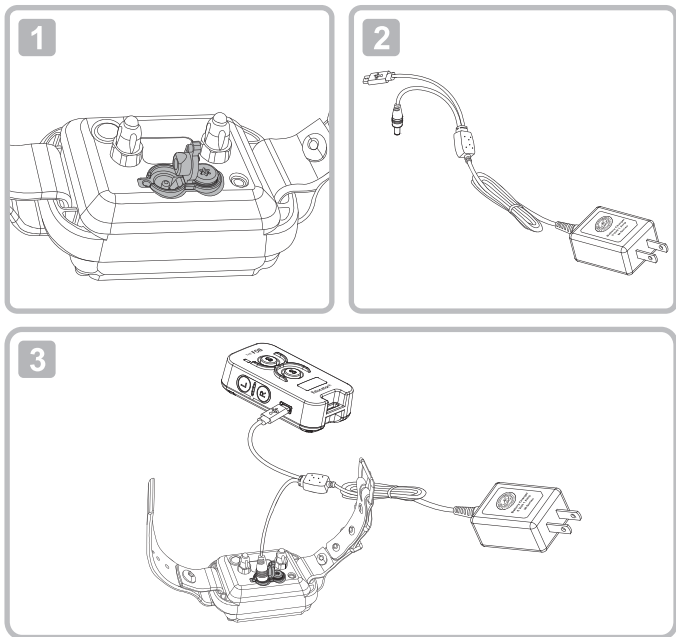

10

TURNING YOUR TRANSMITTER ON/OFF

Transmitter can be turned on and off by pressing the Power-Button.

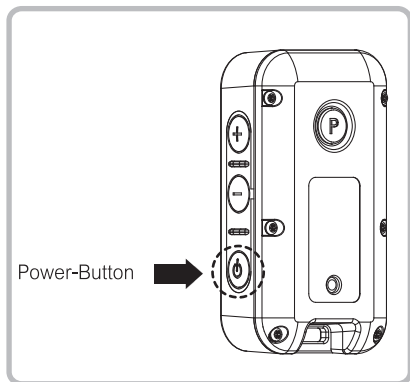

- Power ON : Press the power button for more than 0.5 seconds to turn Transmitter on.



- Power OFF : Press power button for more than 1.5 seconds to turn Transmitter off.

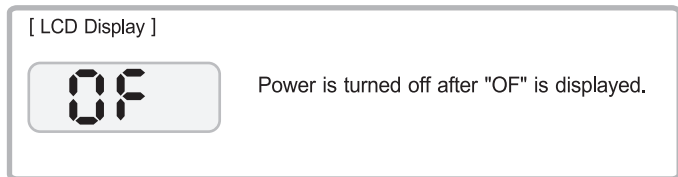

TURNING YOUR RECEIVER ON/OFF

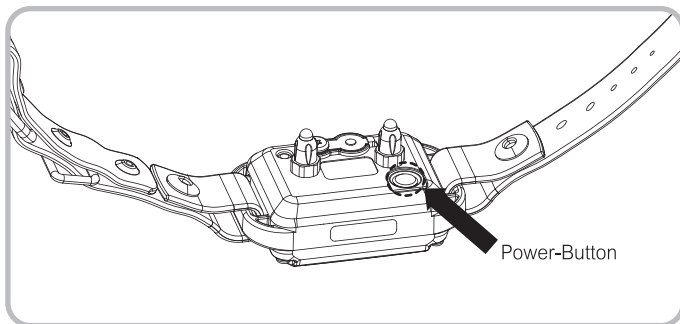

Collar Receiver can be turned on and off by pressing the Power-Button.

- **Power ON** : Press the Power-Button for more than 1 second to turn it on.
- **Power OFF** : Press the Power-Button for more than 1 second to turn it off.

CORRECTLY FITTING COLLAR



The collar should be adjusted to allow the "contact points" to have direct contact with the skin. You should be able to fit a couple of fingers between the collar strap and your dog's skin.

Too tight poses the risk of skin irritation and discomfort. Too loose and the contact points will not be able to administer the stimulation reliably and can cause skin irritation due to chafing. Short hair breeds may need the 3/8" microprobes offered as an accessory item, contact customer service for details. The optimal position for the collar receiver is on either side of the dog's windpipe. If the factory installed 5/8" contact points are not making good contact due to thick fur, see page 39 for changing contact points

IMPORTANT NOTICE

To prevent the occurrence of skin irritations, the collar receiver should not be worn for more than 10-12 hours per day and should be rotated every few hours. Dogs should never sleep with it on overnight or in their kennel. Should your dog experience skin irritations from over exposure to the contact points remove the collar receiver unit immediately and stop using your e-collar until all skin irritations are completely healed. Antibiotic ointment will aid in the healing process. Some dog breeds have extra thick fur or extra short fur that requires special contact points. Please contact our customer service or visit www.ecollar.com for more information.

560B THE LCD DISPLAY DESCRIPTION

[LCD Display]



Display	Description
1D	Indicates Dog 1
88	(1) Indicates Current Stimulation Level in Standby and Stimulation Mode ("0~HI" Level) (2) Displays text for other settings and operations
V	Indicates HI-Vibration
v	Indicates LOW-Vibration
T	Indicates Tone
+	Indicates Rising Stimulation and Step to Increase Stimulation Level

14

560B FUNCTION DESCRIPTION

- Stimulation

While the button is pressed, the preset stimulation level is transmitted.

(Maximum operating time : 10 seconds)

- Rising Stimulation

While the button is pressed, the level increases from the currently set stimulation level to the set max level for a predetermined time interval.

(Stimulation Max Level and time interval can be set separately.)

- Vibration

While the button is pressed, it transmits a vibration. Two vibration modes available.

(LOW(weak vibration) / HI(strong vibration))









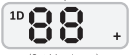

- Tone or Tone followed by Stimulation (Pavlovian Conditioning)

- Tone followed by Stimulation (Stimulation Level is not "0") : While the button is pressed, the tone is transmitted for 1.25 seconds.

If the button is pressed longer than 1.25 seconds, the current level stimulation is transmitted." (Maximum operating time 10 seconds)

- Tone (Stimulation Level is "0") : While the button is pressed, only tone is transmitted instead of stimulation.



560B BUTTON OPERATION

Button	Function	Description	LCD Display
Black Ⓢ	Assigned Function in [P2] for 1Dog Mode - Stimulation - Rising Stimulation - Tone - LOW-Vibration - HI-Vibration	Stimulation	
		Rising Stimulation	 
		Tone or Tone followed by Stimulation * Level "0" : Tone only * Level "1~H" : Tone followed by Stimulation	
		LOW-Vibration	
		HI-Vibration	
		Red Ⓢ	Assigned Function in [P3] for 1Dog Mode - Stimulation - Rising Stimulation - Tone - LOW-Vibration - HI-Vibration
Rising Stimulation	 		
Tone or Tone followed by Stimulation * Level "0" : Tone only * Level "1~H" : Tone followed by Stimulation			
LOW-Vibration			
HI-Vibration			



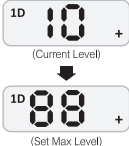

560B BUTTON OPERATION

Button	Function	Description	LCD Display
Ⓛ	Light ON/OFF	Select Light Operation Press the button within 1 second. flickering - steady - off in turn	
		Light OFF * Press the Ⓛ-button for more than 1 second or longer to power light off.	
Ⓡ	Rising Stimulation Time Set	Select time to reach Max Level in Rising Stimulation mode. (Keep pressing the Ⓡ-button, "5 sec->2 sec->1 sec->0 sec->1 sec->1 sec->2 sec->5 sec ...")	 ↓ ↓ ↓
⊕ / ⊖	Stimulation Level UP/DOWN	Stimulation Level UP/DOWN	
⏻	Power ON/OFF	Press and hold Power button for more than 1 second to turn power on.	 ↓ ↓
		Press and hold Power button for more than 1.5 second to turn power off.	

560B BUTTON OPERATION

Button	Function	Description	LCD Display
Stimulation Level = 0 + (P) Program + 2 Seconds (P1) 3 Seconds (P2) 4 Seconds (P3)	Programming Mode	When the (P) Program Button is pressed for 2 seconds it enters (P1), holding for an additional 1 second it will enter (P2), and holding for an additional 1 second it will enter (P3).	
(P) Program + Black (S)	Rising Stimulation	Activates Rising Stimulation.	
(P) Program + (-)	Lock (+) . (-) Level when "1D" icon is blinking in the display.	<ul style="list-style-type: none"> - When "1D" icon on the display is blinking, pressing the (P) button and (-) button at the same time will activate the Level Lock function. - "1D" icon changes from blinking to solid. - Pressing (+) or (-) button after Level Lock function is activated, the stimulation level does not change and only beeps. 	 <p>(1D icon will be solid after activation)</p> <p>(Display changes for a while when pressing (+) or (-) button during Level Lock)</p>
	Unlock (+) . (-) Level when "1D" icon is solid in the display.	<ul style="list-style-type: none"> - When "1D" icon on the display is solid, pressing the (P) button and (-) button at the same time will deactivate the Level Lock function. - "1D" icon changes from solid to blinking. 	 <p>(1D icon will be blinking after deactivation)</p>

560B BUTTON OPERATION

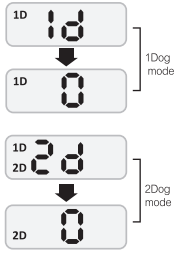
Button	Function	Description	LCD Display
Stimulation Level = 0 +  + 	Pairing	Pairs / Syncs collar receiver to transmitter.	
Stimulation Level = 0 +  Program +  + 3 Seconds	Change 1Dog / 2Dog Mode	Changes from 1Dog mode to 2Dog mode and vice versa.	

560B PROGRAMMING MODE

* How to enter program mode

- (1) After adjusting the stimulation level to "0", press and hold the **P**-button on the back of transmitter for 2 seconds to enter the program mode.
- (2) If you keep holding the button while entering the program mode, the LCD display cycles every 1 second in the order of "**P1** → **P2** → **P3** → **P1**...".

Press and hold the **P**-button to display the mode you want to set.

Release to enter the setting mode.

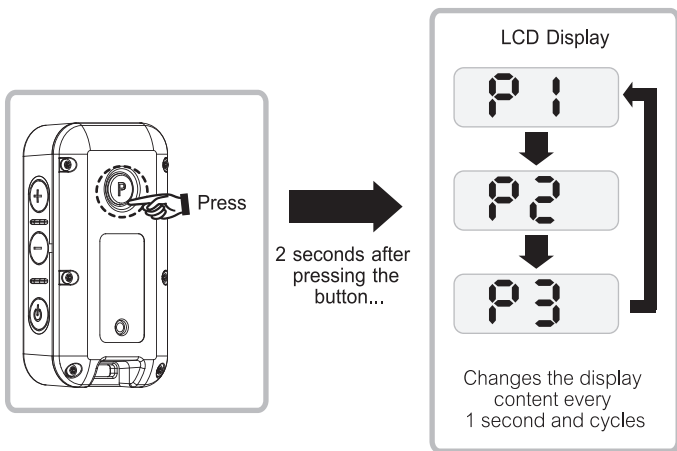

560B PROGRAMMING MODE

- In the program mode, the functions of the **(S)** (Black)-button and **(S)** (Red)-button can be set respectively.
- After setting the function of each button, press the **(P)**-button to save the changes and exit the program mode.

MODE	Setting Value	LCD Display
(P1)	<p>Sets the maximum stimulation level. (Settable level : 5 ~ HI)</p> <p>* Set the level value with (+), (-)-button.</p>	
(P2)	<p>Sets the operation function of the (S) (Black)-button. (Stimulation → Rising Stimulation → Tone → LOW Vibration → HIGH Vibration)</p> <p>Select the mode by pressing (S) (Black)-Button</p>	
(P3)	<p>Sets the operation function of the (S) (Red)-button. (Stimulation → Rising Stimulation → Tone → LOW Vibration → HIGH Vibration)</p> <p>Select the mode by pressing (S) (Red)-Button</p>	

560B PROGRAMMING MODE

* If the maximum level limit is set in **[P1]**, it will not go above the set value when raising the stimulation level with the **(+)**-button.

* Setting stimulation level Increasing step

- You can increase the stimulation level by using the **(+)**-button.
(The default setting is "5" <increase level value by 5>, and can be set to "1" or "10"..)

- Setting Procedure

1. Enter "**[P2]**" in program mode.
2. Press the **(S)** (Black)-button to select the "**5**" icon.
3. Press the **(+)**-button to display the desired setting among "1+", "5+" and "10+".
4. Press the **(P)**-button to save changes and exit program mode.

Increasing Step	Operation	LCD Display
1 Step	Until LCD shows desired step as "1 +", repeat pressing (+) -Button.	
5 Step	Until LCD shows desired step as "5 +", repeat pressing (+) -Button.	
10 Step	Until LCD shows desired step as "10 +", repeat pressing (+) -Button.	

* Regardless of the setting of the level increasing step, level decreasing step when press **(-)**-Button is fixed by 1 step.

HOW TO FIND THE PROPER STIMULATION LEVEL

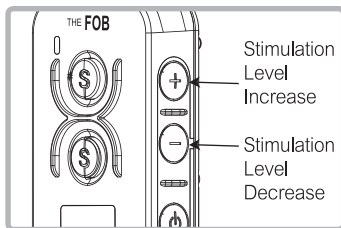

The stimulation level increases when you press \oplus -Button and the stimulation level decreases when you press \ominus -Button

It is highly recommended that the user practices changing levels and modes before putting the collar receiver on a dog.

Setting the correct stimulation level for your dog is very important. To set your “conditioning” stimulation level, correctly put the collar receiver on your dog (see page 12 for instructions). Let the dog get used to the collar receiver for a couple of hours.

While watching your dog, turn the level to “0” and press the continuous stimulation button. Slowly turn the stimulation up at a rate of approximately 2-3 levels per second. When your dog first perceives the stimulation, usually between 5 and 20, release the button. This is your “conditioning” stimulation level. You may need to increase the “conditioning” level a few levels to get your dog to respond at first, some dogs are more stubborn and need more stimulation. The boosted level is typically 5 to 20 levels higher than the “conditioning” level.

560B STIMULATION LEVEL BUTTON LOCK/UNLOCK





The stimulation level set by the user can be locked and unlocked.

• Stimulation Level Button Lock

- Holding down (P)-Button and pressing (L)-Button at the same time to activate the Stimulation Level Button Lock function when "1D" icon on the LCD display is blinking (Stimulation Level Button Unlock Status).
- After the Stimulation Level Button Lock function is activated, the "1D" icon on the LCD changes solid.
- When the Stimulation Level Up/Down Button, (+) / (-) is pressed, a beep sounds and the stimulation does not change.

• Stimulation Level Button Unlock

- Holding down (P)-Button and pressing (L)-Button at the same time to deactivate the Stimulation Level Button Lock function when "1D" icon on the LCD display is solid (Stimulation Level Button Lock Status).
- After the Stimulation Level Button Lock function is deactivated, the "1D" icon on the LCD changes blinking.

Button	Function	Description	LCD Display
(P) Program + (-)	Lock (+) , (-) Level when "1D" icon is blinking in the display.	- When "1D" icon on the display is blinking, pressing the (P) button and (L) button at the same time will activate the Level Lock function. - "1D" icon changes from blinking to solid. - Pressing (+) or (-) button after Level Lock function is activated, the stimulation level does not change and only beeps.	 (1D icon will be solid after activation)  ↓  (Display changes for a while when pressing (+) or (-) button during Level Lock)
	Unlock (+) , (-) Level when "1D" icon is solid in the display.	- When "1D" icon on the display is solid, pressing the (P) button and (L) button at the same time will deactivate the Level Lock function. - "1D" icon changes from solid to blinking.	 (1D icon will be blinking after deactivation)

24

RISING STIMULATION

It is possible to increase the stimulation from the current level to the set maximum level.

• Rising Stimulation Operation

- Press the Rising Stimulation button to increase the stimulation from the current level to the maximum level.
- The time to reach the maximum stimulation level can be set by pressing the **(R)**-Button.

• Rising Stimulation Operation Button

- Press Stimulation **(S)** (Black)-Button and **(P)**-Button with the current stimulation level not "0".
- In programming mode, set Stimulation **(S)** (Red)-Button to, **10St**, then press Stimulation **(S)** (Red)-Button.

• Set stimulus level rise time

: Time to reach the maximum stimulation level from the current stimulation level can be set.

- Keep pressing the **(R)**-Button in standby, "5 sec->2 sec->1 sec-> 0 sec-> 1 sec -> 2 sec -> 5 sec ..." is changed.
- When you exit the mode from the currently selected screen, the last selected time is automatically set.



LCD Display	Description
	It takes 5 second to reach the maximum stimulation level from the current stimulation level.
	It takes 2 second to reach the maximum stimulation level from the current stimulation level.
	It takes 1 second to reach the maximum stimulation level from the current stimulation level.
	When the button is pressed, it immediately outputs the maximum stimulation level. (Stimulation boosting mode)

- The maximum stimulation level can be set in programming mode.

REPLACE/ADD COLLAR

Occasionally, it is necessary to pair/sync a transmitter to a collar receiver, the following procedure will accomplish this.

1. Turn on the Transmitter
2. Set the stimulation level at "0"
3. Make sure Receiver is turned off.
4. Press the Collar Receiver's Power-Button for more than 5 seconds until green light on receiver flashes rapidly.
5. Immediately after, press and hold **⊖**-button followed by the **Ⓛ**-button until you hear confirmation sound from collar receiver.

HOW TO CHANGE THE TRANSMITTER TO A 2 DOG TRANSMITTER

The button functions will change. The changes are described on on pages 26 through 41. You can change the transmitter back to the 1Dog system (560B) at any time.

1. Turn on the Transmitter.
2. Set the stimulation level at "0"
3. Press the **Ⓟ**-Button followed by the **⊕**-Button simultaneously for more than 2 seconds until you hear the confirmation beeps.
4. Repeat step 2 to return back to a 1 dog system.

ADD/REPLACE COLLAR FOR SECOND DOG

1. Turn on the Transmitter
2. Set the stimulation level at "0" when 2D is displayed on the LCD.
3. Make sure Receiver is turned off.
4. Press the Collar Receiver's Power-Button for more than 5 seconds until green light on receiver flashes rapidly.
5. Immediately after, press and hold **⊖**-button followed by the **Ⓛ**-button until you hear confirmation sound from collar receiver.

562B LCD DISPLAY DESCRIPTION

[LCD Display]



Display	Description
1D 2D	Indicates Dog1 / Dog2 in 2Dog Mode - 1D : Dog1 - 2D : Dog2
	(1) Indicates Current Stimulation Level in Standby and Stimulation Mode ("0~HI" Level) (2) Displays text for other settings and operations
V	Indicates HI-Vibration
v	Indicates LOW-Vibration
T	Indicates Tone
+	Indicates Rising Stimulation and Steps to Increase Stimulation Level

562B FUNCTION DESCRIPTION

- Stimulation

While the button is pressed, the preset stimulation level is transmitted.
(Maximum operating time : 10 seconds)

- Rising Stimulation

While the button is pressed, the level increases from the currently set stimulation level to the set max level for a predetermined time interval.
(Stimulation Max Level and time interval can be set separately.)

- Vibration

While the button is pressed, it transmits a vibration. Two vibration modes available.
(LOW(weak vibration) / HI(strong vibration))

- Tone or Tone followed by Stimulation (Pavlovian Conditioning)

- Tone followed by Stimulation (Stimulation Level is not "0") : While the button is pressed, the tone is transmitted for 1.25 seconds.





If the button is pressed longer than 1.25 seconds, the current level stimulation is transmitted." (Maximum operating time 10 seconds)

- Tone (Stimulation Level is "0") : While the button is pressed, only tone is transmitted instead of stimulation.

562B BUTTON OPERATION

Button	Function	Description	LCD Display
Black Ⓢ	Assigned Function in (P2) for Dog 1 - Stimulation - Rising Stimulation - Tone - LOW-Vibration - HI-Vibration	Dog1 Stimaultion	
		Dog1 Rising Stimulation	
		Dog1 Tone or Tone followed by Stimulation * Level "0" : Tone only * Level "1~HI" : Tone followed by Stimulation	
		Dog1 LOW-Vibration	
		Dog1 HI-Vibration	
Red Ⓢ	Assigned Function in (P3) for Dog 2 - Stimulation - Rising Assigned - Tone - LOW-Vibration - HI-Vibration	Dog2 Stimaultion	
		Dog2 Rising Stimulation	
		Dog2 Tone or Tone followed by Stimulation * Level "0" : Tone only * Level "1~HI" : Tone followed by Stimulation	
		Dog2 LOW-Vibration	
		Dog2 HI-Vibration	



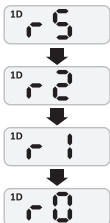
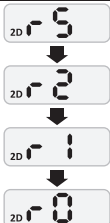







562B BUTTON OPERATION

Button	Function	Description	LCD Display
Ⓛ	Dog1 and Dog2 Light ON/OFF	Select Dog1 Light operation when displaying 1D on LCD Press the button within 1 second. flickering - steady - off in turn	 (Dog1 Light)
		Select Dog2 Light operation when displaying 2D on LCD Press the button within 1 second. flickering - steady - off in turn	 (Dog2 Light)
		Dog1 Light OFF when 1D is displayed on LCD * Press the Ⓛ-button for more than 1 second or longer to power light off.	 (Dog1 Light OFF)
		Dog2 Light OFF when 2D is displayed on LCD * Press the Ⓛ-button for more than 1 second or longer to power light off.	 (Dog2 Light OFF)
Ⓡ	Dog1 Rising Stimulation Time Set	When 1D is displayed on the LCD Select time interval to the maximum level in Dog1 Rising Stimulation. (Keep pressing the Ⓡ-button, "5 sec->2 sec->1 sec-> 0 sec-> 1 sec-> 2 sec->5 sec ...")	
	Dog2 Rising Stimulation Time Set	When 2D is displayed on the LCD Select time interval to the maximum level in Dog2 Rising Stimulation. (Keep pressing the Ⓡ-button, "5 sec->2 sec->1 sec-> 0 sec-> 1 sec-> 2 sec->5 sec ...")	

562B BUTTON OPERATION

Button	Function	Description	LCD Display
⊕ / ⊖	Dog1 Stimulation Level UP/DOWN	When 1D is displayed on the LCD Dog1 Stimulation Level UP/DOWN	
	Dog2 Stimulation Level UP/DOWN	When 2D is displayed on the LCD Dog2 Stimulation Level UP/DOWN	
⏻	Power ON/OFF	Press and hold Power button for more than 1 second to turn power on.	
		Press and hold Power button for more than 1.5 seconds to turn power off.	
Ⓟ Program	Dog1 / Dog2 Change	Dog1->Dog2 (or Dog2->Dog1) Standby transition	
Stimulation Level = 0 + Ⓟ Program + 2 Seconds P1 3 Seconds P2 4 Seconds P3	Programming Mode	When the Ⓟ Program Button is pressed for 2 seconds it enters P1 , holding for an additional 1 second it will enter P2 , and holding for an additional 1 second it will enter P3 .	

562B BUTTON OPERATION

Button	Function	Description	LCD Display
(P) Program + (-)	Lock (+), (-) Level for Dog1 when "1D" icon is blinking in the display.	<ul style="list-style-type: none"> - When "1D" icon on the display is blinking, pressing the (P) button and (-) button at the same time will activate the Level Lock function. - "1D" icon changes from blinking to solid. - Pressing (+) or (-) button after Level Lock function is activated, the stimulation level does not change and only beeps. 	 (1D icon will be solid after activation)    (Display changes for a while when pressing (+) or (-) button during Level Button Lock activation)
	Lock (+), (-) Level for Dog2 when "2D" icon is blinking in the display.	<ul style="list-style-type: none"> - When "2D" icon on the display is blinking, pressing the (P) button and (-) button at the same time will activate the Level Lock function. - "2D" icon changes from blinking to solid. - Pressing (+) or (-) button after Level Lock function is activated, the stimulation level does not change and only beeps. 	 (2D icon will be solid after activation)    (Display changes for a while when pressing (+) or (-) button during Level Button Lock activation)
	Unlock (+), (-) Level for Dog1 when "1D" icon is solid in the display.	<ul style="list-style-type: none"> - When "1D" icon on the display is solid, pressing the (P) button and (-) button at the same time will deactivate the Level Lock function. - "1D" icon changes from solid to blinking. 	 (1D icon will be blinking after deactivation)
	Unlock (+), (-) Level for Dog2 when "2D" icon is solid in the display.	<ul style="list-style-type: none"> - When "2D" icon on the display is solid, pressing the (P) button and (-) button at the same time will deactivate the Level Lock function. - "2D" icon changes from solid to blinking. 	 (2D icon will be blinking after deactivation)

562B BUTTON OPERATION

Button	Function	Description	LCD Display
(P) Program + (S) (Black)	Dog1 Rising Stimulation	Dog1 Rising Stimulation	<p>1D 10 + (Current Level) ↓ 1D 88 + (Set Max Level)</p>
(P) Program + (S) (Red)	Dog2 Rising Stimulation	Dog2 Rising Stimulation	<p>2D 10 + (Current Level) ↓ 2D 88 + (Set Max Level)</p>
Stimulation Level = 0 + (-) + (L)	Dog1 Pairing	When 1D is displayed on the LCD, Execute Pairing for Dog1	<p>1D PA</p>
	Dog2 Pairing	When 2D is displayed on the LCD, Execute Pairing for Dog2	<p>2D PA</p>
Stimulation Level = 0 + (P) Program + (+) + 3 Seconds	Change 1Dog / 2Dog Mode	1Dog-> 2Dog mode change (toggle action)	<p>1D 1d } 1Dog mode ↓ 1D 0 } 1D 2d } 2Dog mode ↓ 2D 0 }</p>

562B PROGRAMMING MODE

* How to enter program mode

- (1) After adjusting the stimulation level to "0", press and hold the **P**-button on the back of transmitter for 2 seconds to enter the program mode.
- (2) If you keep holding the button while entering the program mode, the LCD display cycles every 1 second in the order of "**P1** → **P2** → **P3** → **P1**...".

Press and hold the **P**-button to display the mode you want to set.
Release to enter the setting mode.

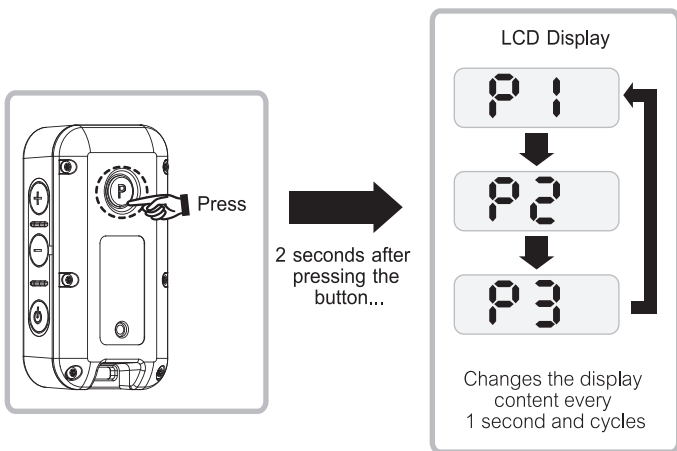

562B PROGRAMMING MODE

- In the program mode, the setting of 1D (DOG1) can be selected by pressing the **(S)**(Black)-button, and the setting of 2D(DOG2) can be selected by pressing the **(S)**(Red)-button.
- After setting the function of each button, press the **(P)**-button to save the changes and exit the program mode.

MODE	Setting Value	LCD Display
(P1)	The maximum level limit of the DOG1 stimulation can be set. (Settable level : 5 ~ HI) * Select 1D(DOG1) with (S) (black)-button. * Set the level value with (+) , (-) -button.	
	The maximum level limit of the DOG2 stimulation can be set. (Settable level : 5 ~ HI) * Select 2D(DOG2) with (S) (Red)-button. * Set the level value with (+) , (-) -button.	
(P2)	Sets the operation function of the (S) (Black)-button (Dog1). (Stimulation → Rising Stimulation → Tone → LOW Vibration → HIGH Vibration) Select the mode by pressing (S) (Black)-Button	

562B PROGRAMMING MODE

MODE	Setting Value	LCD Display
P3	Sets the operation function of the S (Red)-button (Dog2). (Stimulation → Rising Stimulation → Tone → LOW Vibration → HIGH Vibration) Select the mode by pressing S (Red)-Button	

* If the maximum level limit is set in **P1**, it will not go above the set value when raising the stimulation level with the **+**-button.

* **+**-button stimulation level increase value setting

- You can increase the stimulation level by using the **+**-button.
 (The default setting is "5" <increase level value by 5>, and can be set to "1" or "10"..)
- Setting method
 1. DOG1 setting
 - 1-1. Enter "**P2**" in program mode.
 - 1-2. Press the **S** (Black)-button to select the "**St**" icon.
 - 1-3. Press the **+**-button to display the desired setting among "1+", "5+" and "10+".
 - 1-4. Press the **P**-button to save changes and exit program mode.







562B PROGRAMMING MODE

2. DOG2 setting

2-1. Enter "P3" in program mode.

2-3. Press the (+)-button to display the desired setting among "1+", "5+" and "10+".

2-4. Press the (P)-button to save changes and exit program mode.

Increasing Level	Operation	LCD Display	
1	Press the (+)-button to increase the stimulation level by 1.	 (Dog1 setting)	 (Dog2 setting)
5	Press the (+)-button to increase the stimulation level by 5.	 (Dog1 setting)	 (Dog2 setting)
10	Press the (+)-button to increase the stimulation level by 10.	 (Dog1 setting)	 (Dog2 setting)

* Irrespective of the above setting, pressing the (-)-button decreases the stimulation level by 1.







562B PROGRAMMING MODE

* Setting stimulation level Increasing step

- You can increase the stimulation level by using the \oplus -Button (The default setting is "5" <increase level value by 5>, and can be set to "1" or "10"..)

- Setting Procedure

1. Enters **P2** mode.
2. To select Stimulation Mode for Dog1, press \textcircled{S} (Black)-Button until LCD shows $\overset{10}{5\text{E}}$. To select Stimulation Mode for Dog2, press \textcircled{S} (Red)-Button until LCD shows $\overset{20}{5\text{E}}$ in **P3** mode.
3. Press the \oplus -button to display the desired setting among "1+", "5+" and "10+".
4. Press the \textcircled{P} -button to save changes and exit program mode.

Increasing Level	Operation	LCD Display
1 Step	Until LCD shows desired step as "1 +", repeat pressing \oplus -Button.	 (Dog1 mode)  (Dog2 mode)
5 Steps	Until LCD shows desired step as "5 +", repeat pressing \oplus -Button.	 (Dog1 mode)  (Dog2 mode)
10 Steps	Until LCD shows desired step as "10 +", repeat pressing \oplus -Button.	 (Dog1 mode)  (Dog2 mode)

* Regardless of the setting of the level increasing step, level decreasing step when press \ominus -Button is fixed by 1 step.

562B STIMULATION LEVEL BUTTON LOCK/UNLOCK

The stimulation level for Dog 1 and Dog 2 set by the user can be locked and unlocked.

• Stimulation Level Button Lock

[Dog 1 setting]

- Holding down **(P)**-Button and pressing **(-)**-Button at the same time to activate the Stimulation Level Button Lock function for Dog 1 when "1D" icon on the LCD display is blinking (Stimulation Level Button Unlock Status).
- After the Stimulation Level Button Lock function for Dog 1 is activated, the "1D" icon on the LCD changes solid.
- When the Stimulation Level Up/Down Button, **(+)**/**(-)** is pressed, a beep sounds and the stimulation does not change.

[Dog 2 setting]

- Holding down **(P)**-Button and pressing **(-)**-Button at the same time to activate the Stimulation Level Button Lock function for Dog 2 when "2D" icon on the LCD display is blinking (Stimulation Level Button Unlock Status).
- After the Stimulation Level Button Lock function for Dog 2 is activated, the "2D" icon on the LCD changes solid.
- When the Stimulation Level Up/Down Button, **(+)**/**(-)** is pressed, a beep sounds and the stimulation does not change.

• Stimulation Level Button Unlock









[Dog 1 setting]

- Holding down **(P)**-Button and pressing **(-)**-Button at the same time to deactivate the Stimulation Level Button Lock function for Dog 1 when "1D" icon on the LCD display is solid (Stimulation Level Button Lock Status).
- After the Stimulation Level Button Lock function is deactivated, the "1D" icon on the LCD changes blinking.

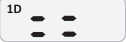
[Dog 2 setting]

- Holding down **(P)**-Button and pressing **(-)**-Button at the same time to deactivate the Stimulation Level Button Lock function for Dog 2 when "2D" icon on the LCD display is solid (Stimulation Level Button Lock Status).
- After the Stimulation Level Button Lock function is deactivated, the "2D" icon on the LCD changes blinking.

562B STIMULATION LEVEL BUTTON LOCK/UNLOCK

Button	Function	Description	LCD Display
(P) Program + (-)	Lock (+), (-) Level for Dog1 when "1D" icon is blinking in the display.	<ul style="list-style-type: none"> - When "1D" icon on the display is blinking, pressing the (P) button and (-) button at the same time will activate the Level Lock function. - "1D" icon changes from blinking to solid. - Pressing (+) or (-) button after Level Lock function is activated, the stimulation level does not change and only beeps. 	 (1D icon will be solid after activation)    (Display changes for a while when pressing (+) or (-) button during Level Button Lock activation)
	Lock (+), (-) Level for Dog2 when "2D" icon is blinking in the display.	<ul style="list-style-type: none"> - When "2D" icon on the display is blinking, pressing the (P) button and (-) button at the same time will activate the Level Lock function. - "2D" icon changes from blinking to solid. - Pressing (+) or (-) button after Level Lock function is activated, the stimulation level does not change and only beeps. 	 (2D icon will be solid after activation)    (Display changes for a while when pressing (+) or (-) button during Level Button Lock activation)
	Unlock (+), (-) Level for Dog1 when "1D" icon is solid in the display.	<ul style="list-style-type: none"> - When "1D" icon on the display is solid, pressing the (P) button and (-) button at the same time will deactivate the Level Lock function. - "1D" icon changes from solid to blinking. 	 (1D icon will be blinking after deactivation)
	Unlock (+), (-) Level for Dog2 when "2D" icon is solid in the display.	<ul style="list-style-type: none"> - When "2D" icon on the display is solid, pressing the (P) button and (-) button at the same time will deactivate the Level Lock function. - "2D" icon changes from solid to blinking. 	 (2D icon will be blinking after deactivation)

562B RISING STIMULATION

- **Rising Stimulation Operation**

- Press the Rising Stimulation button to increase the stimulation from the current level to the maximum level.
- The time to reach the maximum level can be set by pressing the **(R)**-Button.

- **Rising Stimulation Operation Button**

- Dog1 Operation Button
 - Press Stimulation **(S)**(Black)-Button and **(P)**-Button with the current stimulation level not "0".
 - In programming mode, set Stimulation **(S)**(Black)-Button to, **5t**, then press Stimulation **(S)**(Black)-Button.
- Dog2 Operation Button
 - Press Stimulation **(S)**(Red)-Button and **(P)**-Button with the current stimulation level not "0".
 - In programming mode, set Stimulation **(S)**(Red)-Button to, **5t**, then press Stimulation **(S)**(Red)-Button.

- **Set stimulus level rise time**

- : Time to reach the maximum stimulation level from the current stimulation level can be set.
- Keep pressing the **(R)**-Button in standby, "5 sec->2 sec->1 sec-> 0 sec-> 1 sec -> 2 sec -> 5 sec ..." is changed.
- When you exit the mode from the currently selected screen, the last selected time is automatically set.

562B RISING STIMULATION

Dog1 Setting

: In standby mode, press (P)-Button to display 1D and press (R)-Button to set time.



LCD Display	Description
	It takes 5 second to reach the maximum stimulation level from the current stimulation level.
	It takes 2 second to reach the maximum stimulation level from the current stimulation level.
	It takes 1 second to reach the maximum stimulation level from the current stimulation level.
	When the button is pressed, it immediately outputs the maximum stimulation level.(Dog1 Stimulation boosting mode)

- The maximum stimulation level can be set in programming mode.

Dog2 Setting

: In standby mode, press (P)-Button to display 2D and press (R)-Button to set time.

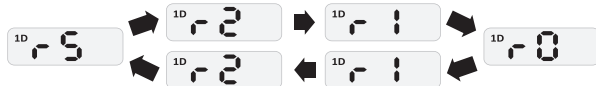

LCD Display	Description
	It takes 5 second to reach the maximum stimulation level from the current stimulation level.
	It takes 2 second to reach the maximum stimulation level from the current stimulation level.
	It takes 1 second to reach the maximum stimulation level from the current stimulation level.
	When the button is pressed, it immediately outputs the maximum stimulation level.(Dog2 Stimulation boosting mode)

- The maximum stimulation level can be set in programming mode.

FINGER TRAINER

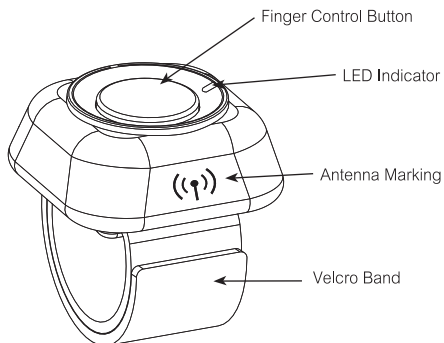

There is no power switch on Finger Trainer because it is always turned on. To minimize battery consumption, it will enter standby mode after 2 hours of inactivity.

If the Finger Control Button is pressed during standby mode, it exits from standby mode.

* Caution : To reduce antenna interference, make sure your fingers do not cover the antenna markings.

PAIRING FINGER TRAINER WITH TRANSMITTER

1. Prepare Transmitter and Finger Trainer for pairing.

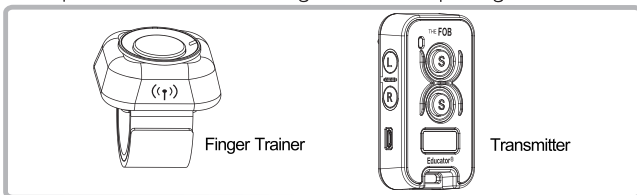

2. While holding down the control button on the Finger Trainer, turn on Transmitter

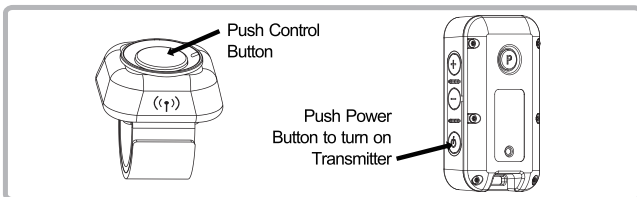

3. Release the stimulation button on the Finger Trainer when transmitter is turned on.

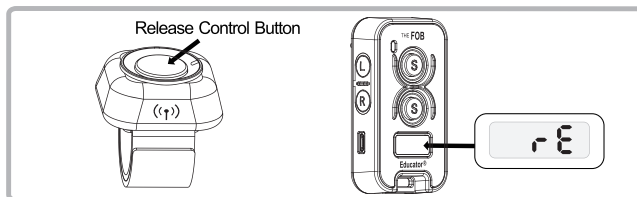

4. Check for successful pairing (Collar Receiver is not to be on the Dog)
- (1) Turn Transmitter stimulation dial to any value other than "0".
 - (2) Press the Finger Trainer control button and make sure the Transmitter is activating the collar receiver. (Stimulation Button (Black S) is the factory default setting.)

CHANGING THE BUTTON THE FINGER TRAINER CONTROLS ON THE TRANSMITTER

The Finger Trainer can be set to control any one of the 2 Buttons of the Transmitter, S(Black) and S(Red).

- How to set the Finger Trainer to control different Transmitter buttons.

Simply push the desired Transmitter Button simultaneously with the POWER button.

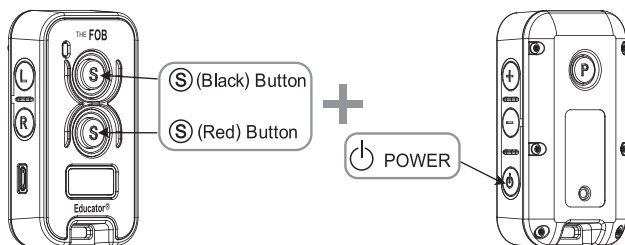

• One Dog Mode (1D)

Finger Trainer Control Button	How To Set	Possible Functions
S(Black) Button (Default)	POWER Button + S(Black) Button	Stimulation, Rising Stimulation, Tone, Vibration.
S(Red) Button	POWER Button + S(Red) Button	

• Two Dog Mode (2D)

Finger Trainer Control Button	How To Set	Possible Functions
S(Black) Button (Default)	POWER Button + S(Black)-Button	1Dog - Stimulation, Rising Stimulation, Tone, Vibration.
S(Red) Button	POWER Button + S(Red)-Button	2Dog - Stimulation, Rising Stimulation, Tone, Vibration.

NOTE: The Finger Trainer controls the physical button, not the function of the button. The Transmitter controls the function.

TURN ON/OFF FINGER TRAINER DETECTION FUNCTION FOR POWER SAVE

In order to detect the signal from Finger Trainer, transmitter will be woke up continuously, which consumes significant battery power.

If you did not purchase a Finger Trainer Button or do not use it, follow the steps below to reduce battery consumption.

1. To turn off the Finger Trainer detection function.
 - Press P + L button for 2 seconds at volume level "0".
 - LCD Display : "rE" and "oF"

NOTE: Finger Trainer detection function will remain off until reprogramed by following the steps below.

2. To turn on the Finger Trainer detection function.
 - Power+Black S or Power+Red S button
 - LCD Display : "rE"

3. Finger Trainer Detection will enter idle mode when button is inactive for more than 2 hours, to reduce battery consumption.
When any button on Transmitter is pressed it will automatically exit idle mode.

OPERATING DISTANCE AND BATTERY OF FINGER TRAINER

- Operating distance between Finger Trainer and Transmitter is maximum 12 feet.
- CR2032 3 Volt Lithium Battery is used.
- To replace battery, simply remove the 4 small screws on the back of the Finger Trainer.
- Battery Life is Approximately 1 Year, life will vary with usage

TESTING YOUR E-COLLAR

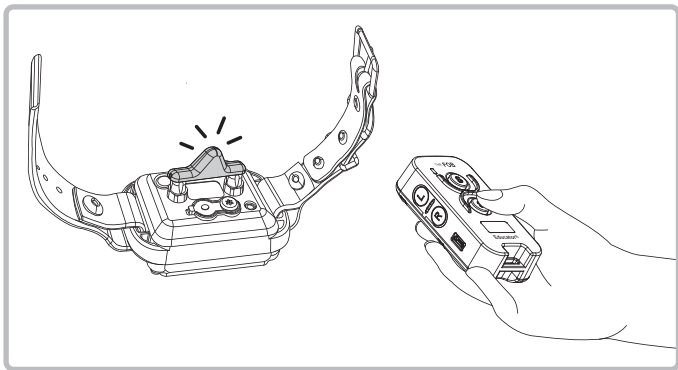

If you need to test the stimulation, hold the test light against the contact points on the collar receiver. This test will let you know that the collar receiver is generating the proper sensation to the dog, it should brighten in a smooth fashion as the dial is turned up.

Some people find it easier to hold the collar receiver on their forearm while slowly turning the stimulation up using the continuous mode, typically as humans we will begin to feel the simulation around a level 8 to 25 depending on the dryness of the skin.

Feel free to contact us if you have need help, 1-260-357-0051.

REPLACING THE CONTACT POINTS

The standard 5/8" contact points are used for most dogs. Thicker fur breeds require the longer 3/4" contact points. Replace the 5/8" contact points by following the instructions below using the enclosed contact point tool.

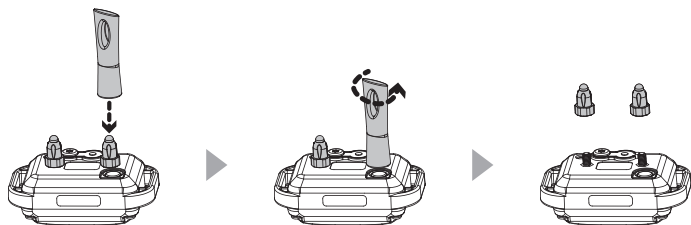

1. Loosen both contact points by rotating the contact point counter-clockwise using the contact point tool.

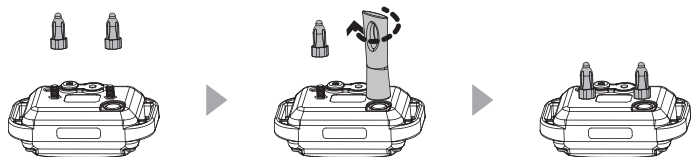

2. Install the 3/4" contact points onto the bolt and tighten the contact points by rotating them clockwise with the contact point tool.

* For short haired breeds such as boxers, dachshund, pit bulls, etc, and thick fur breeds please visit our website or contact us to inquire about special contact points for your dog.

IMPORTANT TRAINING TIPS

E-Collars can be utilized to reinforce commands that your dog already knows or as a learning tool when combined with leash pressure. It should be noted that they are not intended to replace basic leash obedience training, but rather to enhance your ability to communicate with your dog. For optimal outcomes, it is recommended to utilize the minimal amount of stimulation necessary to capture your dog's attention. A composed and consistent approach to training will consistently yield better long-term results. It is strongly advised that owners of aggressive dogs consult a professional trainer for evaluation prior to incorporating an e-collar. Various e-collar training techniques are recommended by different professional trainers. We believe that as the owner, you are best equipped to determine the most effective technique for your dog. For first-time users, we suggest immersing yourself in learning about the proper techniques or seeking the guidance of a professional e-collar trainer. The method employed in initially introducing the e-collar is crucial to the success of the training.

You can find helpful training videos by searching for E-Collar Technologies on YouTube and subscribing to our channel, as we regularly post new content. Additionally, please consider "Liking" our Facebook page to receive further training advice and connect with other e-collar users.

**Good Luck with your training from your friends at
E-Collar Technologies**

TROUBLESHOOTING

? My Receiver / Transmitter is not turning on

- A Make sure the collar receiver is fully charged. Collar receiver light should turn green when the battery is connected to the charger.

? My Receiver is not responding

- A Check Receiver's indicator light is blinking green and Transmitter LCD is on. Check to make sure the collar receiver's indicator light is red when the stimulation button is pressed.

- A Try pairing/syncing the transmitter to the receiver. (Page 25)



? The receiver doesn't seem to provide stimulation to the dog

- A Remove Contact points from Receiver. Connect Test Light to the receiver and test for stimulation. If the test light is blinking, receiver is providing stimulation.

? Max range of device has been decreased

- A Check Transmitter's battery condition. Working range decreases when the battery level is low.
Keep your fingers from touching the antenna. See the bottom of page 11 for the proper technique to maximize range.

? You cannot change the stimulation level of the Transmitter

- A Make sure 1D or 2D on transmitter LCD is blinking. If 1D or 2D icons are solid, you cannot change stimulation. You can unlock the stimulation at any time by press -Button while pressing -Button.

CONTACT US FOR EXPERT HELP WITH YOUR E-COLLAR

TWO YEAR WARRANTY

To register your product, kindly visit our website at www.ecollar.com. Click on the warranty registration link and complete the necessary information. We kindly ask that you register your product within 30 days of your purchase. If you are unable to access a computer, please feel free to contact one of our dedicated customer service representatives at 1-260-357-0051. They will be happy to assist you in registering your product. If, for any reason, your product is not registered properly, proof of purchase will not be required to obtain warranty coverage. We will be able to estimate your purchase date based on the serial number. It is important to note that misuse, improper maintenance, lost or stolen units, and dog damages are not covered under the manufacturer's warranty. We strive for your complete satisfaction and aim to provide exceptional service.

**“Making Bad Dogs Good
and Good Dogs Better!”**

ACCESSORIES

- Titanium Hypo-Allergenic Contact Pints



- Thick Fur Contact Points



- Short Point Comfort Pads



- Wrist Remote Keeper



- Ultra Wing Contact Point Comfort Pads



- Gear Keeper



- Bungee Collar



- Quick Snap Bungee Collar



www.ecollar.com

SAFETY AND GENERAL INFORMATION

- The FE-560B/562B Education Collar complies with all National and International Standards and Guidelines for human exposure to radio frequency electromagnetic energy.
- Nearly all electronic devices are susceptible to electromagnetic interference (EMI) if inadequately shielded or designed without precautions to EMI.
- Operating Frequency Band is 915MHz.

IMPORTANT NOTICE

1. To avoid Electromagnetic Interference and/or compatibility conflicts, please turn off your transmitter and collar receiver in any facility where posted notices instruct you to do so. Never use your equipment in close proximity of a Hospital or Health Care Facility or enter the facility without turning off both units.
2. Any change or modification made to the transmitter, including the supplied antenna, without the expressed written approval of E-Collar Technologies Incorporated could void your authority to operate.

SAFETY AND GENERAL INFORMATION

NOTICE

Possible Metal Allergy

Dogs vary in sensitivity and may develop symptoms of a metal allergy.

Which may include irritation, redness, hair loss, sores, etc.

Please rotate collar receiver from side to side daily to check for allergies.

If allergies occur, hypoallergenic contact points are available for purchase

at www.ecollar.com or 260-357-0051

NOTICE TO PREVENT WATER DAMAGE

If Receiver is exposed to water on a regular basis, tighten screws once or twice a month depending on the frequency of water exposure.

Please make sure screws are snug but not overly tight.

This will help prevent internal water damage.

ITEM SHOULD BE PLACED OUT OF THE REACH OF CHILDREN

This product is not meant to be used by individuals (including children) with limited physical, sensory, or cognitive abilities, or those lacking expertise and understanding, unless they are under the supervision or guidance of a person responsible for their safety. This also applies to the cleaning and upkeep of the item.

The item should exclusively be used with the power supply (charger) provided with the product.

SAFETY AND GENERAL INFORMATION

WARNING

- **INGESTION HAZARD:** This product contains a button cell or coin battery.
- **DEATH** or serious injury can occur if ingested.
- A swallowed button cell or coin battery can cause **Internal Chemical Burns** in as little as **2 hours**.
- **KEEP** new and used batteries **OUT OF REACH of CHILDREN**
- **Seek immediate medical attention** if a battery is suspected to be swallowed or inserted inside any part of the body.



- A. Remove and immediately recycle or dispose of used batteries according to local regulations and keep away from children.
Do NOT dispose of batteries in household trash or incinerate.
- B. Even used batteries may cause severe injury or death.
- C. Call a local poison control center for treatment information.
- D. Battery model: CR2032
- E. The nominal battery voltage: 3V.
- F. Non-rechargeable batteries are not to be recharged.
- G. Do not force discharge, recharge, disassemble, heat above (manufacturer's specified temperature rating) or incinerate.
Doing so may result in injury due to venting, leakage or explosion resulting in chemical burns.
- H. Products with non-replaceable coin cell batteries.

TECHNICAL SPECIFICATIONS

Transmitting and receiving standard frequency	915 Mhz
Operating range (maximum effective range of open space)	300 yard range
Degree of protection	IP68
Finger Trainer	CR2032 3 Volt
Transmitter battery (Li_Po)	400mAh
Collar Receiver battery (Li_Po)	400mAh
Battery voltage	3.7V ~ 4.2V
USB charging voltage	5V
Time for battery fully charged	1-2 Hours
Collar Receiver Battery Life (Standby mode)	24 ~ 48 Hours
Transmitter Battery Life (Standby mode)	Battery last more then 2 week
Working temperature	0 ~ 55°C
Storage temperature / Humidity	-40 ~ 85 °C / 30%
<p>"Risk of fire or explosion if the battery is replaced by an incorrect type" "Use an adapter that satisfies PS2 or LPS"</p>	



E-Collar Technologies Incorporated

2120 Forrest Park Drive
Garrett, IN 46738-1887
1-260-357-0051 (US & International)

sales@ecollar.com
www.ecollar.com
customerservice@ecollar.com



Thank you for Supporting American Workers

Copyright 2020 E-Collar Technologies Incorporated

All Rights Reserved.